

## CONEXIONES COMPACTAS DE JUNTA MECANICA

### CONEXIONES DE JUNTA MECANICA DE HIERRO DUCTIL CLASE 350 DE 2" A 36"

MJ x MJ			CODOS 90°			MJ x PE	
Dim	No. De parte	Peso	A	B	T	No. de parte	Peso
2	DMB290	14	3.0		.30		
3	DMB390	23	4.0	9.5	.34	DME390	22
4	DMB490	27	4.0	10.2	.35	DME490	26
6	DMB690	42	5.0	11.7	.37	DMB690	40
8	DMB890	60	6.5	12.7	.39	DME890	57
10	DMB1090	90	7.5	14.7	.41	DME1090	88
12	DMB1290	115	9.0	15.7	.43	DME1290	110
14	DMB1490	219	11.5	19.5	.51	DME1490	206
16	DMB1690	274	12.5	20.5	.52	DME1690	260
18	DMB1890	335	14.0	22	.54	DME1890	311
20	DMB2090	400	15.5	23.5	.57	DME2090	370
24	DMB2490	565	18.5	26.5	.61	DME2490	518
30	DMB3090	930	25.5		.64		
36	DMB3690	1365	24.5		.76		

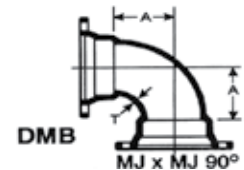

MJ x MJ			CODOS 45°			MJ x PE	
Dim	No. De parte	Peso	A	B	T	No. de parte	Peso
2	DMB245	13	1.5		.30		
3	DMB345	21	1.5	7.0	.34	DME345	19
4	DMB445	23	2.2	7.7	.35	DME445	22
6	DMB645	33	3.2	8.7	.37	DME645	31
8	DMB845	50	3.7	9.2	.39	DME845	48
10	DMB1045	73	4.7	10.2	.41	DME1045	70
12	DMB1245	95	5.7	11.2	.43	DME1245	91
14	DMB1445	170	5	13.0	.51	DME1445	165
16	DMB1645	214	5.5	13.5	.52	DME1645	209
18	DMB1845	253	6.0	14.0	.54	DME1845	246
20	DMB2045	310	7.0	15.0	.57	DME2045	293
24	DMB2445	410	7.5	15.5	.61	DME2445	383
30	DMB3045	716	11.5		.64		
36	DMB3645	1110	14.5		.76		

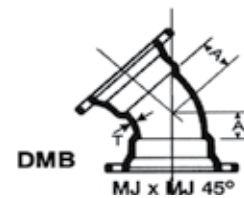

MJ x MJ			CODOS 22 1/2°			MJ x PE	
Dim	No. De parte	Peso	A	B	T	No. de parte	Peso
3	DMB322	16	1.00	6.5	.34	DME322	13
4	DMB422	18	1.50	7	.35	DME422	16
6	DMB622	32	2.50	7.5	.37	DME622	31
8	DMB822	46	2.50	8.0	.39	DME6822	45
10	DMB1022	64	3.00	8.5	.41	DME1022	63
12	DMB1222	84	3.50	9.0	.43	DME1222	82
14	DMB1422	172	5.00	13.0	.51	DME1422	167
16	DMB1622	211	5.50	13.5	.52	DME1622	200
18	DMB1822	255	6.00	14.0	.54	DME1822	248
20	DMB2022	315	7.00	15.0	.57	DME2022	290
24	DMB2422	420	7.50	15.5	.61	DME2422	387
30	DMB3022	710	11.50		.64		
36	DMB3622	1130	11.50		.76		



MJ x MJ			CODOS 11 1/4°			MJ x PE	
Dim	No. De parte	Peso	A	B	T	No. de parte	Peso
3	DMB311	14	1.00	6.50	.34	DME311	13
4	DMB411	16	1.25	6.75	.35	DME411	17
6	DMB611	30	1.50	7.00	.37	DME611	29
8	DMB811	42	1.75	7.25	.39	DME811	41
10	DMB1011	58	2.00	7.50	.41	DME1011	56
12	DMB1211	74	2.25	7.75	.43	DME1211	71
14	DMB1411	72	5.00	13.00	.51	DME1411	167
16	DMB1611	211	5.50	13.50	.52	DME1611	201
18	DMB1811	254	6.00	14.00	.54	DME1811	248
20	DMB2011	305	7.00	15.00	.57	DME2011	291
24	DMB2411	403	7.50	15.50	.61	DME2411	388
30	DMB3011	715	11.50		.64		
36	DMB3611	1135	11.50		.76		

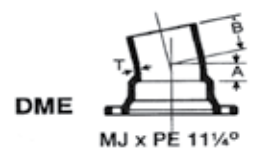

# CONEXIONES COMPACTAS DE JUNTA MECANICA

## CODOS 90°, CODOS 45°, CRUCES Y ADAPTADORES

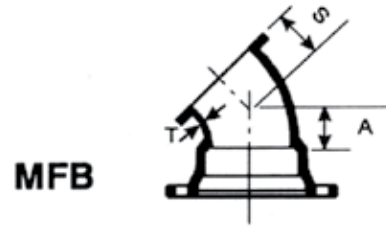
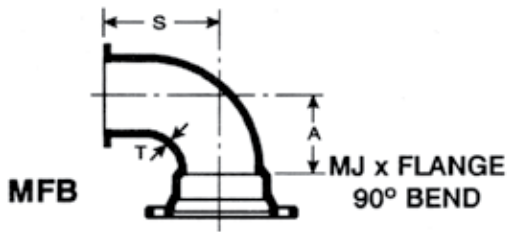

**CODOS 90°: MJ x BRIDA**

Dim	No. De parte	A	S	T	Peso
3	MFB390	4.0	5.5	.34	20
4	MFB490	4.7	6.5	.35	26
6	MFB690	6.2	8.0	.37	47
8	MFB890	7.2	9.0	.39	68
10	MFB1090	9.2	11.0	.41	102
12	MFB1290	10.2	12.0	.43	134
16	MFB1690	12.5	15.0	.52	306
20	MFB2090	15.5	18.0	.57	441
24	MFB2490	18.5	22.0	.61	618

**CODOS 45°: MJ x BRIDA**

Dim	No. De parte	A	S	T	Peso
3	MFB345	1.5	3.0	.34	17
4	MFB445	2.2	4.0	.35	22
6	MFB645	3.2	5.0	.37	37
8	MFB845	3.7	5.5	.39	57
10	MFB1045	4.7	6.5	.41	83
12	MFB1245	5.7	7.5	.43	111
16	MFB1645	5.5	8.0	.52	239
20	MFB2045	6.0	9.5	.57	338
24	MFB2490	7.0	11.0	.61	442

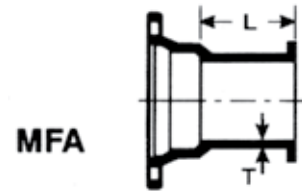
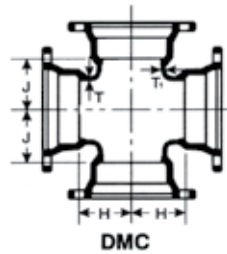

**CRUCES**

Dim		No. De parte	H	J	T	T <sub>1</sub>	Peso
Línea	Ramal						
3	3	DMC33	3.0	.34	.34	38	38
4	3	DMC43	4.0	.35	.34	49	49
4	4	DMC44	4.0	.35	.35	57	57
6	4	DMC64	4.0	.37	.35	68	68
6	6	DMC66	5.0	.37	.37	88	88
8	4	DMC84	4.0	.39	.35	99	99
8	6	DMC86	5.0	.39	.37	100	100
8	8	DMC88	6.0	.39	.39	130	130
10	3	DMC1033	7.0	.41	.34	115	115
10	4	DMC1044	7.0	.41	.35	120	120
10	6	DMC1065	7.0	.41	.37	125	125
10	8	DMC1086	7.0	.41	.39	130	130
10	10	DMC1010	7.0	7.0	.41	.41	210
12	4	DMC1244	8.5	.43	.35	150	150
12	6	DMC1265	8.5	.43	.37	159	159
12	8	DMC1286	8.5	.43	.39	165	165
12	10	DMC1210	7.0	8.5	.43	.41	190
12	12	DMC1212	8.5	8.5	.43	.43	280
14	8	DMC1488	10.5	.51	.39	259	259
14	14	DMC1414	11.0	10.5	.51	.51	413
16	6	DMC1667	12.0	.52	.37	250	250
16	8	DMC1688	12.0	.52	.39	289	289
16	10	DMC1610	9.0	12.0	.52	.41	345
16	12	DMC1612	10.0	12.0	.52	.43	397
16	16	DMC1616	12.5	12.0	.52	.52	578

**ADAPTADORES: MJ x BRIDA**

Dim	No. De parte	L	T	Peso
3	MFA3	3.5	.34	12
4	MFA4	3.5	.35	21
6	MFA6	3.5	.37	28
8	MFA8	3.5	.39	49
10	MFA10	3.5	.41	60
12	MFA12	3.5	.43	99
14	MFA14	5.0	.51	147
16	MFA16	5.0	.52	186
18	MFA18	5.0	.54	206
20	MFA20	5.0	.57	252
24	MFA24	5.0	.61	324
30	MFA30	7.0	.64	420

## CONEXIONES COMPACTAS DE JUNTA MECANICA

### TEES

Dim	MJ X MJ				T	T <sub>1</sub>	MJ X FLANGE			
	No. de parte	Peso	H	J			No. parte	Peso	H	L
2X2	DMT22	24	3.00	3.00	.30	.30	DMF33	N/A	N/A	N/A
3X3	DMT33	29	3.00	3.00	.34	.34				
4X2	DMT42	30	3.00	4.00	.35	.30	DMF43	N/A	N/A	N/A
4X3	DMT43	30	3.50	4.00	.35	.34	DMF44	40	4.00	6.5
4X4	DMT44	32	4.00	4.00	.35	.35	DMF63	50	4.00	8.0
6X3	DMT63	44	N/A	N/A	N/A	N/A	DMF64	55	5.00	8.0
6X4	DMT64	46	4.00	5.00	.37	.35	DMF66	56	5.00	8.0
6X6	DMT66	56	5.00	5.00	.37	.37	DMF83	70	4.00	9.0
8X3	DMT83	52	N/A	N/A	N/A	N/A	DMF84	75	5.00	9.0
8X4	DMT84	60	4.00	6.50	.39	.35	DMF86	80	5.00	9.0
8X6	DMT86	72	5.00	6.50	.39	.37	DMF88	85	6.50	9.0
8X8	DMT88	86	6.50	6.50	.39	.39	DMF103	90		
10X3	DMT103	75	4.00	7.50	.41	.34	DMF104	90	5.00	11.0
10X4	DMT104	78	4.00	7.50	.41	.35	DMF106	100	5.00	11.0
10X6	DMT106	90	5.00	7.50	.41	.37	DMF108	103	6.50	11.0
10X8	DMT108	105	6.50	7.50	.41	.39	DMF1010	126	7.50	11.0
10X10	DMT1010	120	7.50	7.50	.41	.41				
12X3	DMT123	90	4.00	8.75	.43	.34	DMF124	118	5.00	12.0
12X4	DMT124	94	4.00	8.75	.43	.35	DMF126	120	5.00	12.0
12X6	DMT126	110	5.00	8.75	.43	.37	DMF128	130	6.50	12.0
12X8	DMT128	125	6.50	8.75	.43	.39	DMF1210	149	7.50	12.0
12X10	DMT1210	140	7.50	8.75	.43	.41	DMF1212	159	8.75	12.0
12X12	DMT1212	160	8.75	8.75	.43	.43				
14X6	DMT146	229	7.00	11.00	.51	.37				
14X8	DMT148	252	8.00	11.00	.51	.39				
14X10	DMT1410	274	9.00	11.00	.51	.41				
14X12	DMT1412	306	10.00	11.00	.51	.43				
14X14	DMT1414	351	11.00	11.00	.51	.51	DMF166	285	6.00	15.0
16X6	DMT166	270	7.00	12.50	.52	.37	DMF168	306	8.00	15.0
16X8	DMT168	289	8.00	12.50	.52	.39	DMF1610	324	9.00	15.0
16X10	DMT1610	317	9.00	12.50	.52	.41	DMF1612	358	10.00	15.0
16X12	DMT1612	344	10.00	12.50	.52	.43				
16X14	DMT1614	392	11.50	12.50	.52	.51	DMF186	321	7.00	15.5
16X16	DMT1616	435	12.50	12.50	.52	.52				
18X6	DMT186	306	7.00	13.50	.54	.37	DMF206	360	7.00	17.0
18X8	DMT188	335	8.00	13.50	.54	.39	DMF208	384	8.00	17.0
18X18	DMT1818	518	13.50	13.50	.54	.54				
20X6	DMT206	348	7.00	14.00	.57	.37				
20X8	DMT208	372	8.00	14.00	.57	.39				
20X10	DMT2010	402	9.00	14.00	.57	.41				
20X12	DMT2012	432	10.00	14.00	.57	.43				
20X16	DMT2016	526	12.50	14.00	.57	.52				
20X18	DMT2018	577	13.50	14.00	.57	.54				
20X20	DMT2020	623	14.00	14.00	.57	.57	DMF246	406	7.00	19.0
24X6	DMT246	415	7.00	16.00	.61	.37	DMF248	418	8.50	19.0
24X8	DMT248	450	8.50	16.00	.61	.39				
24X10	DMT2410	470	10.00	16.00	.61	.41				
24X12	DMT2412	510	11.00	16.00	.61	.43				
24X16	DMT2416	581	13.00	16.00	.61	.52				
24X18	DMT2418	630	13.50	16.00	.61	.54				
24X20	DMT2420	665	14.00	16.00	.61	.57				
24X24	DMT2424	788	16.00	16.00	.61	.61				
30X6	DMT306	665	7.00	20.00	.64	.37				
30X12	DMT3012	816	10.00	20.00	.64	.43				
30X16	DMT3016	950	12.50	20.00	.64	.52				
30X24	DMT3024	1248	16.00	20.00	.64	.61				
30X30	DMT3030	1350	20.00	20.00	.64	.64				
36X12	DMT3612	1205	10.00	23.50	.76	.43				
36X16	DMT3616	1270	12.50	23.50	.76	.52				
36X24	DMT3624	1400	16.00	23.50	.76	.61				
36X36	DMT3636	1950	23.50	23.50	.76	.76				

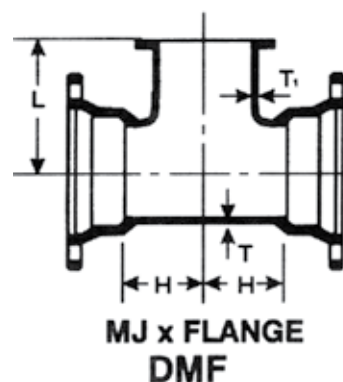
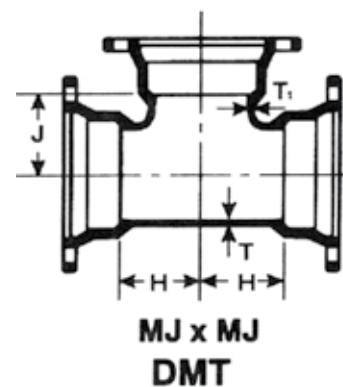

## CONEXIONES COMPACTAS DE JUNTA MECANICA

### TEES Y CRUCES CON ROSCA, TAPAS CIEGAS Y LATERALES DE 45°

#### TEES Y CRUCES CON ROSCA (TAP)

Dim	TEE		CRUZ		T	L	Dim rosca
	No. De parte	Peso	No. De parte	Peso			
3	DTT3	18	DTC3	18	.34	6	2
4	DTT4	25	DTC4	25	.35	6	2
6	DTT6	35	DTC6	35	.37	6	2
8	DTT8	55	DTC8	55	.39	6	2
10	DTT10	70	DTC10	70	.41	6	2
12	DTT12	84	DTC12	84	.43	6	2
16	DTT16	202	DTC16	202	.52	8	2
20	DTT20	259	DTC20	259	.57	10	2
24	DTT24	320	DTC24	320	.61	10	2

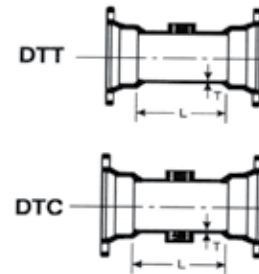

#### TAPAS CIEGAS HEMBRA Y MACHO

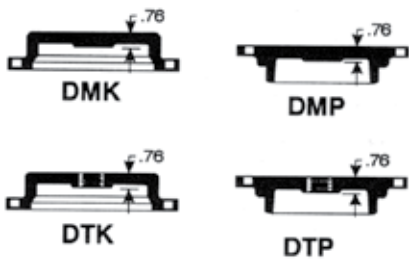

Dim	Hembra solida		Hembra C/Rosca		Macho Solida		Macho C/Rosca	
	No. De parte	Peso	No. De parte	Peso	No. De parte	Peso	No. De parte	Peso
2	DMK2	7	DTK3	7	DMP3	9	DTP3	9
3	DMK3	10	DTK4	10	DMP4	10	DTP4	10
4	DMK4	12	DTK6	12	DMP6	20	DTP6	20
6	DMK6	16	DTK8	16	DMP8	35	DTP8	35
8	DMK8	26	DTK10	26	DMP10	50	DTP10	50
10	DMK10	36	DTK12	36	DMP12	68	DTP12	68
12	DMK12	48	DTK14	48	DMP14	77	DTP14	77
14	DMK14	72	DTK16	72	DMP16	101	DTP16	101
16	DMK16	98	DTK18	98	DMP18	121	DTP18	121
18	DMK18	114	DTK20	114	DMP20	139	DTP20	139
20	DMK20	129	DTK24	129	DMP24	181	DTP24	181
24	DMK24	171	DTK30	171	DMP30	330	DTP30	330
30	DMK30	330						

#### TAPAS CIEGAS HEMBRA Y MACHO

Dim	Macho Solida		Peso	T
	No. De parte	No. De parte		
4	DPP4	PTP4	12	.43
6	DPP6	PTP6	20	.47
8	DPP8	PTP8	27	.49
10	DPP10	PTP10	36	.52
12	DPP12	PTP12	47	.54
16	DPP16	PTP16	59	.60

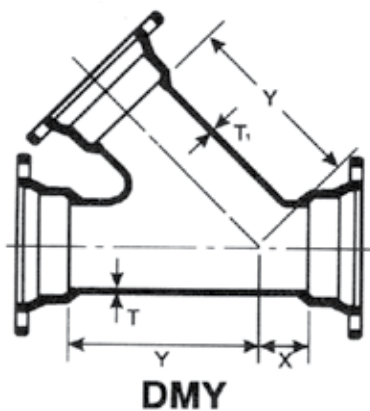
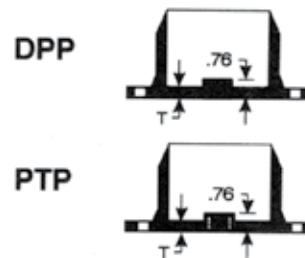

#### LATERALES 45°

Dim		No. De parte	X	Y	T	T <sub>1</sub>	Peso
Linea	Ramal						
3	3	DMY33	2.0	8.5	.34	.34	34
4	4	DMY44	2.5	9.5	.35	.35	50
6	4	DMY64	1.5	11.0	.37	.35	73
6	6	DMY66	3.0	13.0	.37	.37	80
8	4	DMY84	0.5	13.0	.39	.35	106
8	6	DMY86	2.0	14.5	.39	.37	114
8	8	DMY88	3.5	16.0	.39	.39	128
10	4	DMY104	0.0	15.0	.41	.35	150
10	6	DMY106	1.0	16.0	.41	.37	158
10	8	DMY108	2.5	17.0	.41	.39	172
10	10	DMY1010	3.5	19.0	.41	.41	210
12	4	DMY124	0.0	16.5	.43	.35	211
12	6	DMY126	1.5	18.5	.43	.37	220
12	8	DMY128	1.5	18.5	.43	.39	236
12	10	DMY210	3.0	20.0	.43	.41	277
12	12	DMY1212	4.5	22.5	.43	.43	297

## CONEXIONES COMPACTAS DE JUNTA MECANICA

### REDUCERS

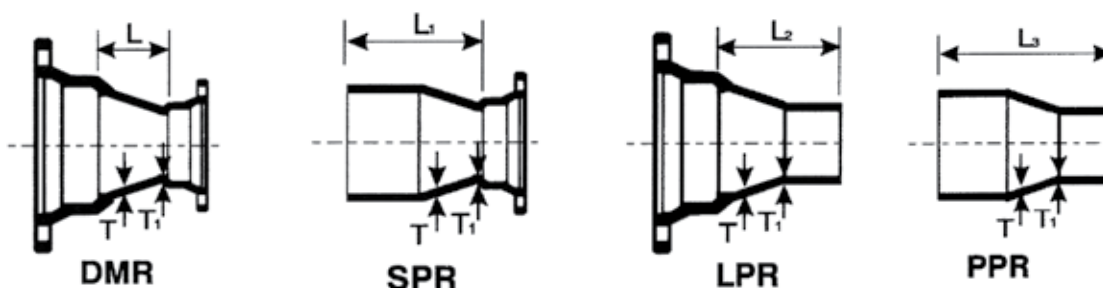

#### REDUCERS

Dim	MJ X MJ			PE X MJ (MJ CHICA)			MJ XPE (MJ GRANDE)			PE X PE			T	T <sub>1</sub>
	No. de parte	Peso	L	No. de parte	Peso	L <sub>1</sub>	No. de parte	Peso	L <sub>2</sub>	No. de parte	Peso	L <sub>3</sub>		
4X2	DMR42 16	2.5	2.5	SPR42	14	8.0							.35	.30
4X3	DMR43 18	3.0	3.0	SPR43	17	8.5	LPR43	18	8.5	PPR43	17	14.0	.35	.34
6X3	DMR63 23	5.0	5.0	SPR63	23	10.5	LPR63	26	10.5	PPR63	25	16.0	.37	.34
8X4	DMR64 24	4.0	4.0	SPR64	26	9.5	LPR64	28	9.5	PPR64	25	15.0	.37	.35
8X4	DMR84 32	5.0	5.0	SPR84	33	10.5	LPR84	34	10.5	PPR86	33	16.0	.39	.35
8X6	DMR86 36	4.0	4.0	SPR86	36	9.5	LPR86	37	9.5	PPR104	35	15.0	.39	.37
10X4	DMR104	46	7.0	SPR104	44	12.5	LPR104	44	12.5	PPR106	47	18.0	.41	.35
10X6	DMR106	48	5.0	SPR106	46	10.5	LPR106	46	10.5	PPR108	46	16.0	.41	.37
10X8	DMR108	50	4.0	SPR108	49	9.5	LPR108	50	9.5	PPR124	50	15.0	.41	.39
12X4	DMR124	58	9.0	SPR124	60	14.5	LPR124	61	14.5	PPR126	59	20.0	.43	.35
12X6	DMR126	60	7.0	SPR126	60	12.5	LPR126	60	12.5	PPR128	60	18.0	.43	.37
12X8	DMR128	60	5.0	SPR128	61	10.5	LPR128	62	10.5	PPR1210	60	16.0	.43	.39
12X10	DMR1210	64	4.0	SPR1210	61	9.5	LPR1210	64	9.5	PPR1210	65	15.0	.43	.41
14X6	DMR146	127	10.0										.51	.37
14X8	DMR148	124	8.0										.51	.39
14X10	DMR1410	120	6.0										.51	.41
14X12	DMR1412	110	5.0										.51	.43
16X6	DMR166	161	16.0	SPR166	139	20.0	LPR166	158	21.0	PPR166	133	29.0	.52	.37
16X8	DMR168	158	13.0	SPR168	134	18.0	LPR168	158	18.0	PPR168	133	26.0	.52	.39
16X10	DMR1610	155	10.0	SPR1610	132	16.0	LPR1610	151	16.0	PPR1610	129	22.0	.52	.41
16X12	DMR1612	148	7.0	SPR1612	124	14.0	LPR1612	141	14.0	PPR1612	119	20.0	.52	.43
16X14	DMR1614	165	5.0				LPR1614	135	13.0				.52	.51
18X6	DMR186	194	16.0										.54	.37
18X8	DMR188	191	13.0										.54	.39
18X12	DMR1812	180	7.0	SPR1812	155	16.0	LPR1812	175	16.0	PPR1812	150	22.0	.54	.43
18X14	DMR1814	200	6.0	SPR1814	175	15.0	LPR1814	190	15.0	PPR1814	160	23.0	.54	.51
18X16	DMR1816	195	5.0				LPR1816	190	13.0				.54	.52
20X6	DMR206	232	22.0	SPR206	201	30.0	LPR206	231	27.5	PPR206	106	35.5	.57	.37
20X8	DMR208	227	19.0	SPR208	198	27.0	LPR208	227	24.5	PPR208	106	32.5	.57	.39
20X10	DMR2010	223	16.0	SPR2010	200	24.0	LPR2010	217	21.5	PPR2010	193	29.5	.57	.41
20X12	DMR2012	216	13.0	SPR2012	186	21.0	LPR2012	211	18.0	PPR2012	190	26.0	.57	.43
20X14										PPR104	195	26.0	.57	.51
20X16	DMR2016	231	7.0	SPR2016	201	15.0	LPR2016	209	15.0		181	23.0	.57	.52
20X18	DMR2018	225	4.0	SPR2018	200	12.0	LPR2018	193	12.0		190	20.0	.57	.54
24X6	DMR246	322	28.0	SPR246	284	36.0	LPR246	320	33.5		283	41.5	.61	.37
24X8	DMR248	318	25.0	SPR248	282	33.0	LPR248	316	30.5		281	38.5	.61	.39
24X10	DMR2410	312	22.0	SPR2410	276	30.0	LPR2410	310	27.5		274	35.5	.61	.41
24X12	DMR2412	306	19.0	SPR2412	275	27.0	LPR2412	299	24.0		262	32.0	.61	.43
24X16	DMR2416	320	12.0	SPR2416	285	21.0	LPR2416	297	21.0		285	29.0	.61	.52
24X18	DMR2418	308	10.0										.61	.54
24X20	DMR2420	300	7.0	SPR2420	270	15.0	LPR2420	283	15.0		240	23.0	.61	.57
30X24	DMR3024	460	10.0										.64	.61
36X24	DMR3624	712	19.0										.76	.61

## CONEXIONES COMPACTAS DE JUNTA MECANICA

### TEES, ADAPTADORES, CONTRABRIDA Y CODOS ESLABON GIRATORIO

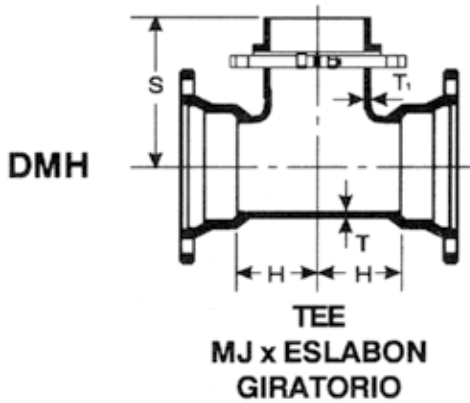

**TEES: MJ x ESLABON GIRATORIO (SWIVEL)**

Dim	No. De parte	H	S	T	T <sub>1</sub>	Peso
6X6	DMH66	5.0	10.0	.37	.37	65
8X6	DMH86	5.0	11.0	.39	.37	85
8X8	DMH88	6.5	11.0	.39	.39	107
10X6	DMH106	5.0	12.5	.41	.37	105
10X8	DMH108	6.5	12.5	.41	.39	118
12X6	DMH126	5.0	13.50	.43	.37	126
12X8	DMH128	6.5	13.50	.43	.39	147
14X6	DMH146	7.0	15.0	.51	.37	230
16X6	DMH166	7.0	16.0	.52	.37	279
16X8	DMH168	8.0	16.0	.52	.39	298
18X6	DMH186	7.0	17.0	.54	.37	307
20X6	DMH206	7.0	18.5	.57	.37	357
20X8	DMH208	8.0	18.5	.57	.39	382
24X6	DMH246	7.0	19.0	.61	.37	445
24X8	DMH248	8.5	19.0	.61	.39	477

**ADAPTADORES: SOLIDA x ESLABON GIRATORIO (SWIVEL)**

Dim	No. De parte	L	T	Peso
4	SSA413	13	.35	29
6	SSA613	13	.37	40
6	SSA618	18	.37	48
6	SSA624	24	.37	57
6	SSA630	30	.37	66
6	SSA636	36	.37	75
6	SSA648	48	.37	94
6	SSA660	60	.37	112
6	SSA672	72	.37	131
8	SSA813	13	.39	54
10	SSA1013	13	.41	69
12	SSA1213	13	.43	87

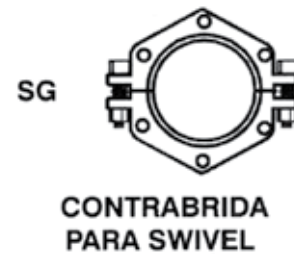
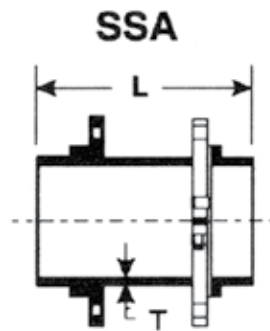

**CONTRABRIDA PARA SWIVEL**

Dim	No. De parte	Peso
4	SG4	8
6	SG6	11
8	SG8	15
10	SG10	18
12	SG12	24

**TEES REDUCTORAS**

Dim	No. De parte	H	J	T	T <sub>1</sub>	Peso
6X4X4	DRT644	5.0	5.00	.37	.35	43
6X4X6	DTR646	5.0	5.00	.37	.35	57
8X6X6	DTR866	5.0	6.50	.39	.37	73
8X6X8	DRT868	6.0	6.50	.39	.37	82
10X6X6	DRT1066	6.5	7.50	.41	.37	86
12X6X6	DRT1266	7.0	8.75	.43	.37	96
12X6X8	DRT1268	7.0	8.75	.43	.39	105

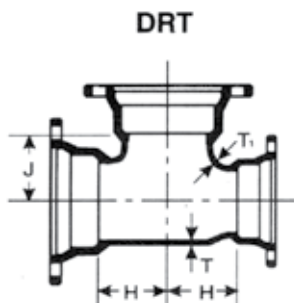

**CODOS ESLABON GIRATORIO x ESLABON GIRATORIO (SWIVEL x SWIVEL)**

Dim	No. De parte	A	B	T	Peso
6	SSB6	10.5	16.0	.36	52
8	SSB8				74
10	SSB10				102

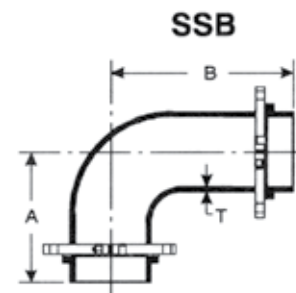

## CONEXIONES COMPACTAS DE JUNTA MECANICA

### DESVIACIONES, CARRETES Y CARRETES DE ESPIGA

#### DESVIACIONES

Dim	MJ x MJ		D	L	L <sub>1</sub>	T	MJ x PE	
	No. De parte	Peso					No. De parte	Peso
3 x 6	DMO36	30	6	9	14.5	.34	DMQ36	29
3 x 12	DMO312	40	12	15	20.5	.34	DMQ312	39
3 x 18	DMO318	49	18	21	26.5	.34	DMQ318	48
3 x 24	DMO324	55	24	27	33.5	.34	DMQ324	53
4 x 6	DMO46	45	6	10	15.5	.35	DMQ46	44
4 x 12	DMO412	55	12	16	21.5	.35	DMQ412	54
4 x 18	DMO418	65	18	22	27.5	.35	DMQ418	63
4 x 24	DMO424	75	24	28	33.5	.35	DMQ424	72
6 x 6	DMO66	55	6	12	17.5	.37	DMQ66	54
6 x 12	DMO612	65	12	18	23.5	.37	DMQ612	64
6 x 18	DMO618	75	18	24	29.5	.37	DMQ618	72
6 x 24	DMO624	85	24	30	35.5	.37	DMQ624	82
8 x 6	DMO86	80	6	13	18.5	.39	DMQ86	78
8 x 12	DMO812	90	12	19	24.5	.39	DMQ812	88
8 x 18	DMO818	100	18	25	30.5	.39	DMQ818	96
10 x 6	DMO106	105	6	15	20.5	.41	DMQ106	102
10 x 12	DMO1012	135	12	21	26.5	.41	DMQ1012	132
10 x 18	DMO1018	165	18	27	32.5	.41	DMQ1018	160
12 x 6	DMO126	118	6	17	22.5	.43	DMQ126	112
12 x 12	DMO1212	153	12	23	28.5	.43	DMQ1212	146
12 x 18	DMO1218	190	18	29	34.5	.43	DMQ1218	184
12 x 24	DMO1224	202	24	35	40.5	.43	DMQ1224	194
12 x 30	DMO1230	213	30	41	46.5	.43	DMQ1230	205

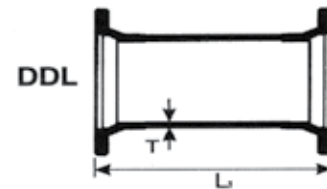
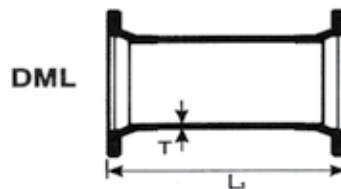
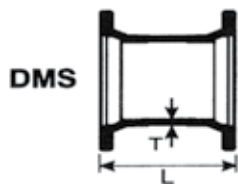
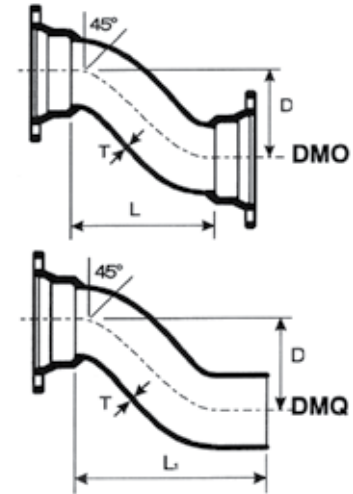

#### CARRETES

Dim	CARRETE CORTO			CARRETE LARGO			T
	No. de parte	Peso	L	No. de parte	Peso	L <sub>1</sub>	
3	DMS3	16	7.5	DML3	18	12	.34
4	DMS4	18	7.5	DML4	22	12	.35
6	DMS6	28	7.5	DML6	36	12	.37
8	DMS8	38	7.5	DML8	46	12	.39
10	DMS10	52	7.5	DML10	66	12	.41
12	DMS12	66	7.5	DML12	77	12	.43
14	DMS14	131	9.5	DML14	160	15	.51
16	DMS16	150	9.5	DML16	186	15	.52
18	DMS18	177	9.5	DML18	230	15	.54
20	DMS20	195	9.5	DML20	260	15	.57
24	DMS24	260	9.5	DML24	345	15	.61
				DML30	600	24	.64
				DML36	835	24	.76

CARRETE DE DOBLE USO			
No. de parte	Peso	L <sub>1</sub>	T
DDL3	23	12	.34
DDL4	32	12	.35
DDL6	50	12	.37
DDL8	65	12	.39
DDL10	89	12	.41
DDL12	104	12	.43

#### CARRETES DE MJ x ESPIGA

Dim	No. De parte	Peso	T	T <sub>1</sub>	A	S	L
3	DCL3	34	.34	.36	3.96	8	20
4	DCL4	49	.35	.37	4.80	8	20
6	DCL6	61	.37	.39	6.90	8	20
8	DCL8	88	.39	.41	9.05	8	20
10	DCL10	105	.41	.43	11.10	8	20
12	DCL12	127	.43	.45	13.20	8	20

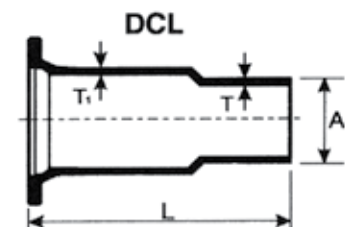

## CONEXIONES COMPACTAS DE JUNTA MECANICA

### TEES Y CRUCES CON ROSCA, TAPAS CIEGAS Y LATERALES DE 45°

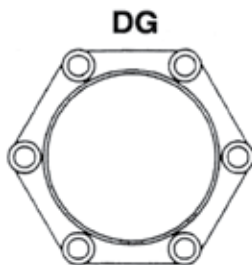

#### CONTRABRIDAS ESTANDAR

Dim	No. De parte	Peso
2	DG2	2
3	DG3	4
4	DG4	5
6	DG6	6
8	DG8	7
10	DG10	10
12	DG12	15
14	DG14	23
16	DG16	28
18	DG18	30
20	DG20	43
24	DG24	50
30	DG30	85
36	DG36	115
42	DG42	180
48	DG48	275

#### EMPAQUES

Dim	ESTANDAR		TRANSICION	
	No. de parte	Peso	No. de parte	Peso
2	MG2			
3	MG3	.25	TG3	.50
4	MG4	.30	TG4	.60
6	MG6	.50	TG6	.75
8	MG8	.75	TG8	1.10
10	MG10	.80	TG10	1.30
12	MG12	1.00	TG12	1.65
14	MG14	1.30		
16	MG16	1.45		
18	MG18	1.60		
20	MG20	1.90		
24	MG24	2.10		
30	MG30	2.30		
36	MG36	2.75		
42	MG42	3.20		
48	MG48	3.65		

#### CONTRABRIDAS DE RETENCION

Diam. nominal del tubo	No. de parte	Peso	D.E. TUBO HIERRO DUCTIL AWWA	PRESION DE TRABAJO AGUA WWP (psl)	TORNILLOS		
					Cant.	Dim	Torque (Ft Lbs)
3	RMG3	5	3.96	350	4	5/8 X2	85
4	RMG4	7	4.80	350	4	5/8 X2	85
6	RMG6	12	6.90	350	6	5/8 X2	85
8	RMG8	16	9.05	250	9	5/8 X2	85
10	RMG10	22	11.10	250	16	5/8 X2	85
12	RMG12	28	13.20	250	16	5/8 X2	85
14	RMG14	45	15.30	250	20	5/8 X2	85
16	RMG16	52	17.40	250	24	5/8 X2	85
18	RMG18	62	19.50	200	24	5/8 X2	85
20	RMG20	75	21.60	200	28	3/4 X 2- 1/2	110
24	RMG24	97	25.80	200	32	3/4 X 2- 1/2	110
30	RMG30	196	32.00	100	40	3/4 X 2- 1/2	110
36	RMG36	246	38.30	100	48	3/4 X 2- 1/2	110
42	RMG42	302	44.50	100	56	3/4 X 2- 1/2	110
48	RMG48	380	50.80	100	64	3/4 X 2- 1/2	110

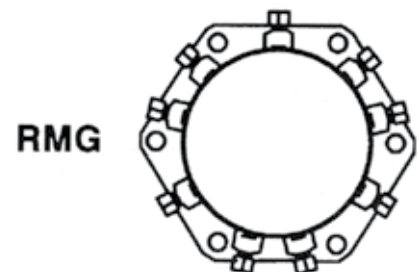



## CONEXIONES COMPACTAS DE JUNTA MECANICA

### PAQUETES Y TORNILLOS CABEZA "T"

**PAQUETE CONTRABRIDA:**

Incluye contrabrida, Empaque MJ y Tornillos T estandar.

Dim	No. De parte	Peso
2	DGP2	6
3	DGP3	7
4	DGP4	8
6	DGP6	12
8	DGP8	15
10	DGP10	20
12	DGP12	25
14	DGP14	37
16	DGP16	43
18	DGP18	47
20	DGP20	61
24	DGP24	72

**PAQUETE CONTRABRIDA DE TRANSICION:**

Incluye contrabrida, Empaque MJ y Tornillos T estandar.

Dim	No. De parte	Peso
3	DXP3	7
4	DXP4	8
6	DXP6	12
8	DXP8	15
10	DXP10	20
12	DXP12	25

**PAQUETE CONTRABRIDA DE RETENCION:**

Incluye contrabrida, Empaque MJ y Tornillos T estandar.

Dim	No. De parte	Peso
3	RGP3	9
4	RGP4	10
6	RGP6	15
8	RGP8	19
10	RGP10	25
12	RGP12	32

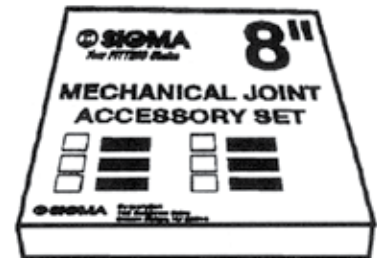

**PAQUETE DE TORNILLOS:**

Incluye Tornillowsy, Empaque MJ

Dim	No. De parte	Peso
3	MGP3	3
4	MGP4	4
6	MGP6	6
8	MGP8	7
10	MGP10	8
12	MGP12	9

**TORNILLOS CABEZA "T" DE ACERO DE BAJA ALEACION Y RESISTENTES A LA CORROSION**

Tornillos Estandar			Tornillos Estandar		
Dim	No. De parte	Peso	Dim	No. De parte	Peso
5/8 X 3	TB30	0.50	3/4 X 3 1/2	ATB35	0.75
3/4 X 3 1/2	TB35	0.75	3/4 X 4	ATB40	1.00
3/4 X 4	TB40	0.85	3/4 X 4 1/2	ATB45	1.25
3/4 X 4 1/2	TB45	1.00	3/4 X 5	ATB50	1.50
3/4 X 5	TB50	1.25			
1 X 6	TB60	2.25			
1 1/4 X 6	TB61	2.50			

